



US00D751785S

(12) **United States Design Patent**  
**Lychwick**

(10) **Patent No.:** **US D751,785 S**

(45) **Date of Patent:** **\*\* Mar. 15, 2016**

(54) **SUPPLE IMPACT SIMULATED TRASH CAN ASSEMBLY**

*Primary Examiner* — Cynthia Ramirez

(74) *Attorney, Agent, or Firm* — Tsz Lung Yeung

(71) Applicant: **Kurt P. Lychwick**, Greenfield, WI (US)

(72) Inventor: **Kurt P. Lychwick**, Greenfield, WI (US)

(57) **CLAIM**

The ornamental design for a supple impact simulated trash can assembly, as shown and described.

(\*\*) Term: **14 Years**

(21) Appl. No.: **29/515,523**

**DESCRIPTION**

(22) Filed: **Jan. 23, 2015**

**Related U.S. Application Data**

(63) Continuation-in-part of application No. 13/901,312, filed on May 23, 2013, now abandoned.

(51) **LOC (10) Cl.** ..... **09-09**

(52) **U.S. Cl.**

USPC ..... **D34/7; D22/117**

(58) **Field of Classification Search**

USPC ..... D34/1-12; 220/908, 908.1; D22/117, D22/199; 463/47.2, 47.5

CPC ..... B65D 25/28; B65F 1/1607; B65F 1/068; B65F 1/1415; B65F 1/08; B65F 1/264

See application file for complete search history.

FIG. 1 is a perspective view of a supple impact simulated trash can assembly in accordance with the present invention.

FIG. 2 is a front view thereof.

FIG. 3 is a rear view thereof.

FIG. 4 is a left end view thereof.

FIG. 5 is a right end view thereof.

FIG. 6 is a top view thereof.

FIG. 7 is a bottom view thereof.

FIG. 8 is a perspective view showing a lid of the supple impact simulated trash can assembly in accordance with the present invention.

FIG. 9 is a front view thereof.

FIG. 10 is a rear view thereof.

FIG. 11 is a left end view thereof.

FIG. 12 is a right end view thereof.

FIG. 13 is a top view thereof.

FIG. 14 is a bottom view thereof.

FIG. 15 is a perspective view showing a trash can of the supple impact simulated trash can assembly in accordance with the present invention.

FIG. 16 is a front view thereof.

FIG. 17 is a rear view thereof.

FIG. 18 is a left end view thereof.

FIG. 19 is a right end view thereof.

FIG. 20 is a top view thereof; and,

FIG. 21 is a bottom view thereof.

The lid and the trashcan are shown separated in FIGS. 8 through 15 and 16 through 21 respectively for convenience of illustration.

The inflating valves shown in broken lines in some of the figures are to show environment and are not part of the claimed design.

(56) **References Cited**

**U.S. PATENT DOCUMENTS**

3,540,170	A *	11/1970	Flowers	.....	A01K 97/01
					135/100
D326,342	S *	5/1992	Doxey	.....	D34/11
5,865,338	A *	2/1999	Conn	.....	B29C 47/0023
					220/623
6,808,081	B1 *	10/2004	Citro	.....	B65D 25/2805
					116/63 P
7,628,289	B1 *	12/2009	Boyd	.....	B65F 1/141
					220/484
D613,018	S *	3/2010	Greene	.....	D34/5
7,766,186	B1 *	8/2010	Brown	.....	B65F 1/02
					220/772
D643,986	S *	8/2011	Soto	.....	D34/1
D742,611	S *	11/2015	Tuncel	.....	D34/1
2009/0026208	A1 *	1/2009	McKenzie	.....	B65F 1/068
					220/495.06

\* cited by examiner

**1 Claim, 19 Drawing Sheets**

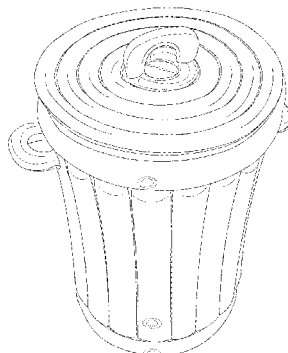

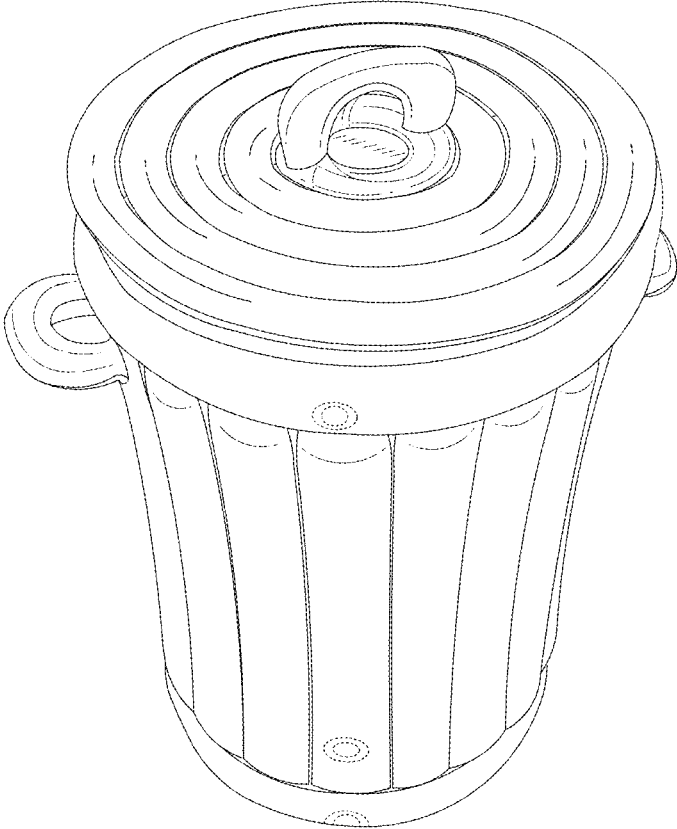

FIG. 1

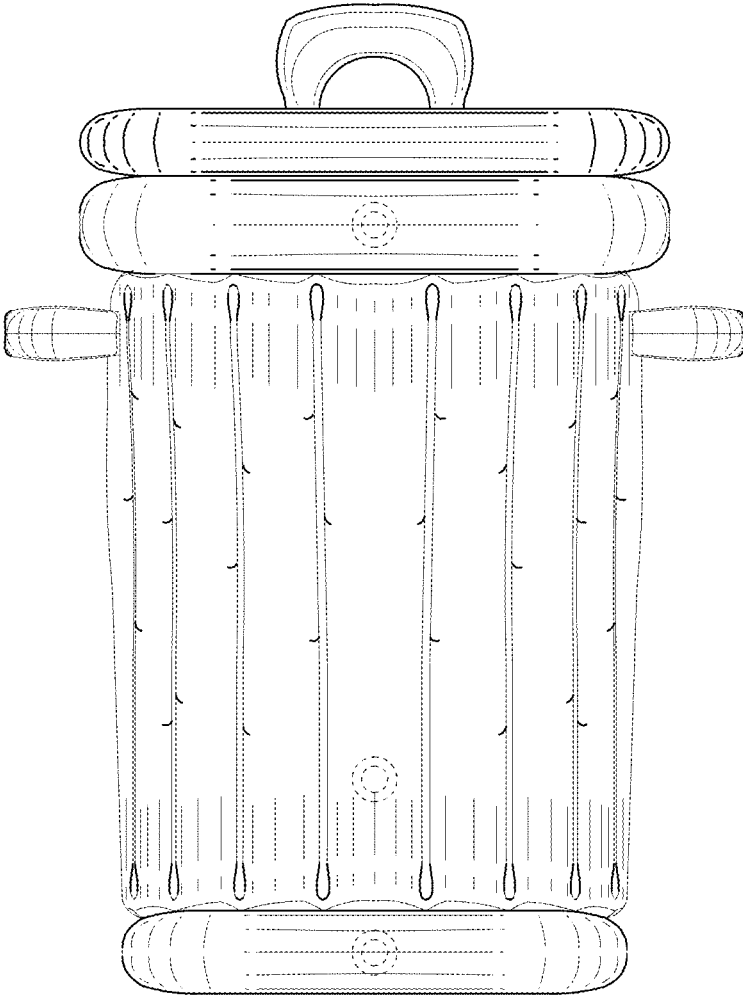

FIG. 2

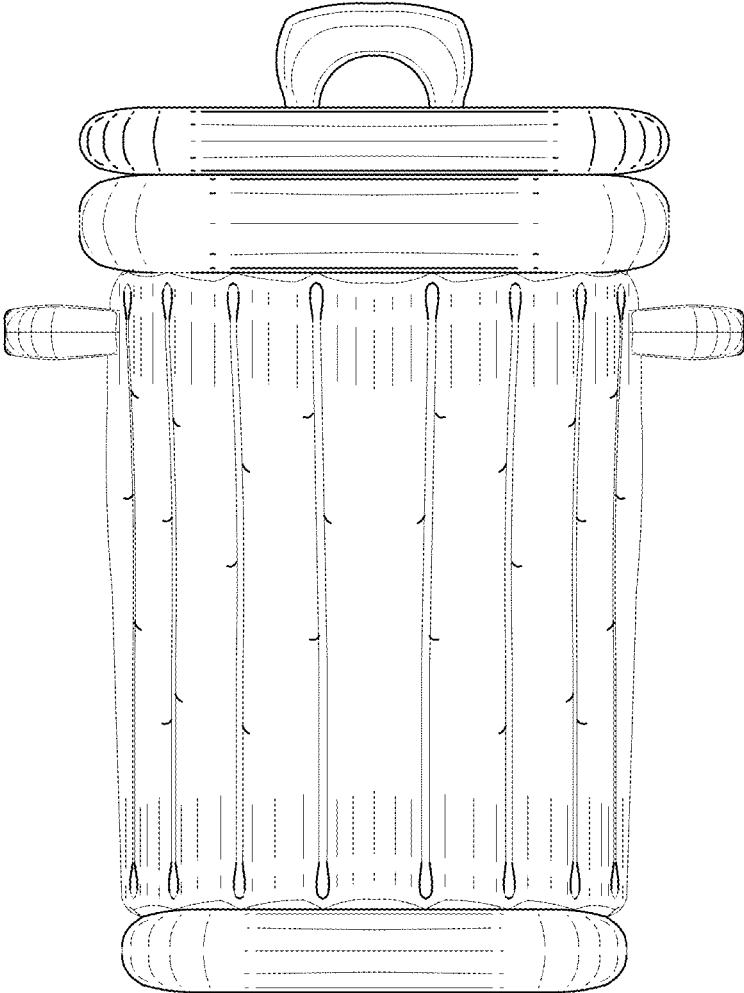

FIG. 3

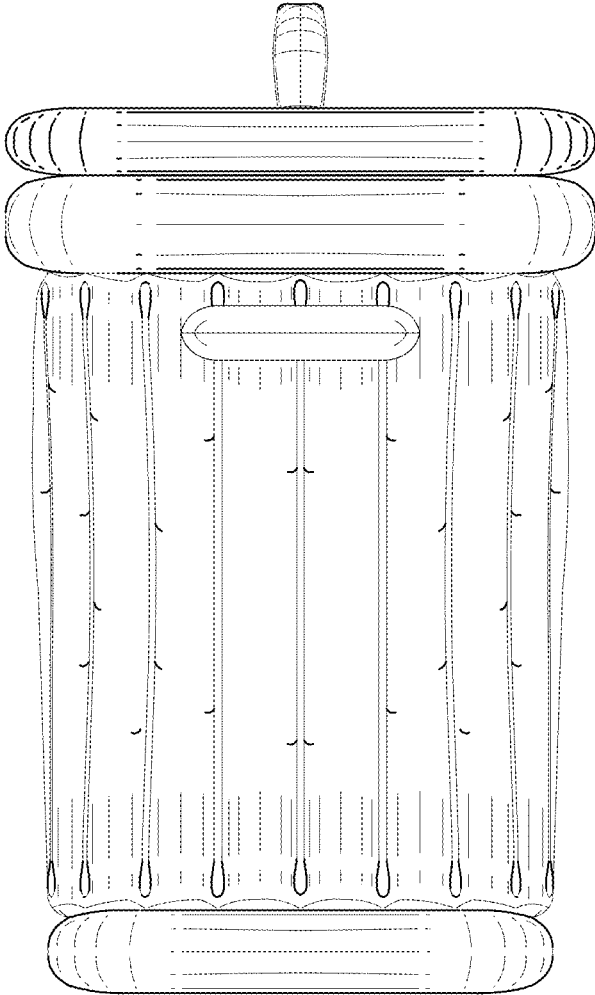

FIG. 4

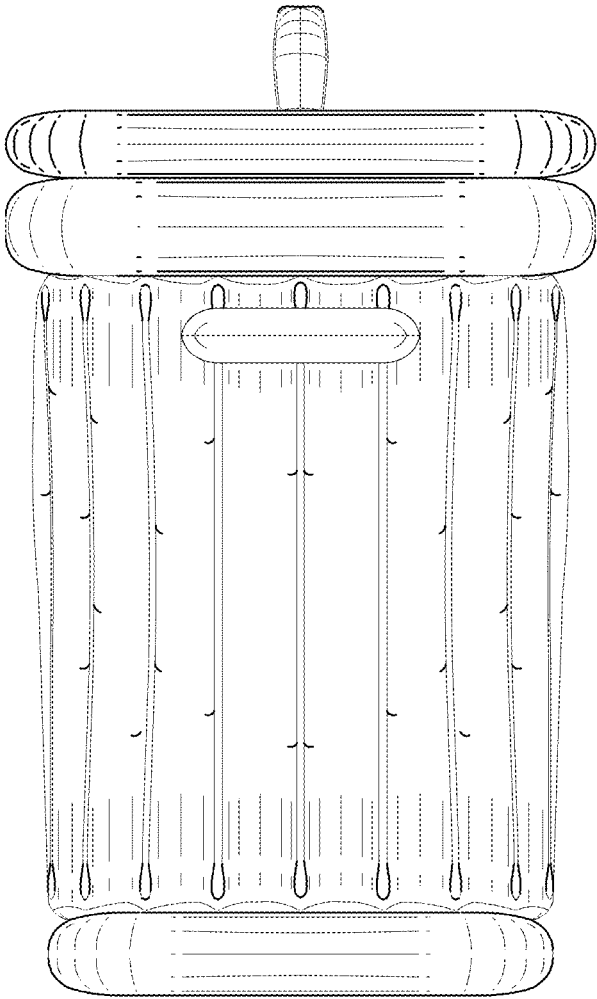

FIG. 5

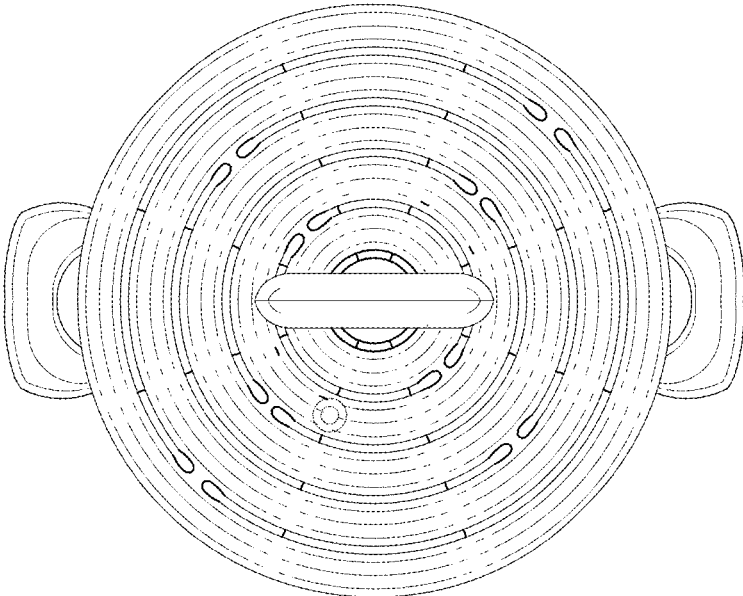

FIG. 6

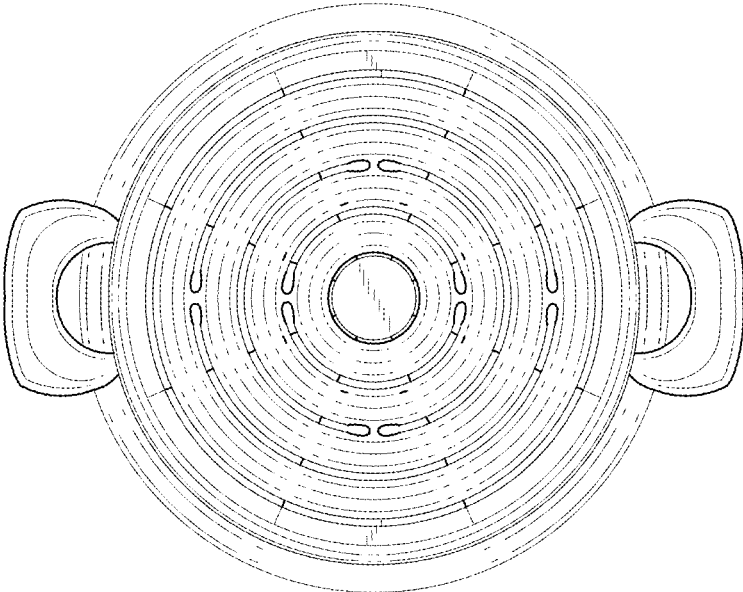

FIG. 7



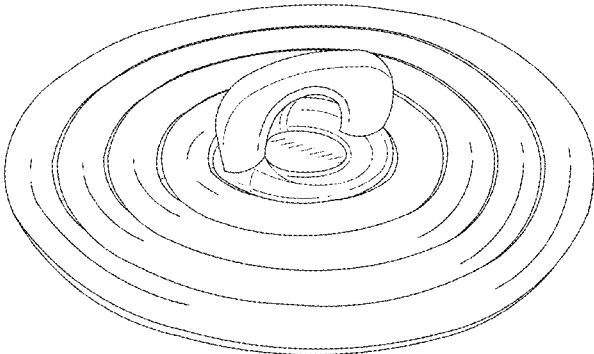

FIG. 8

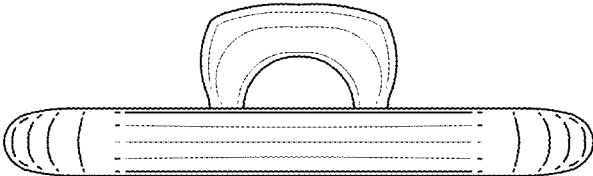

FIG. 9

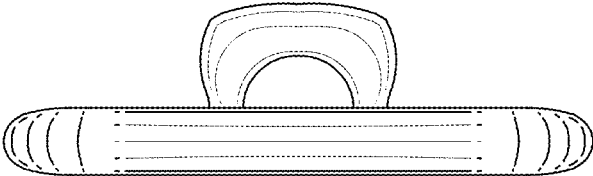

FIG. 10

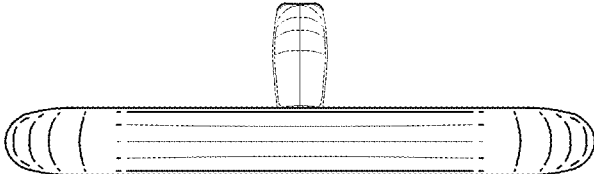

FIG. 11

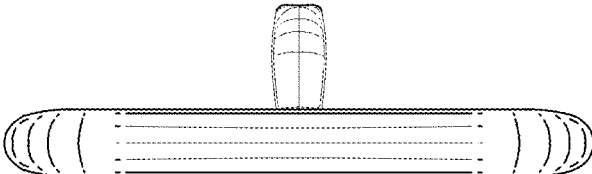

FIG. 12

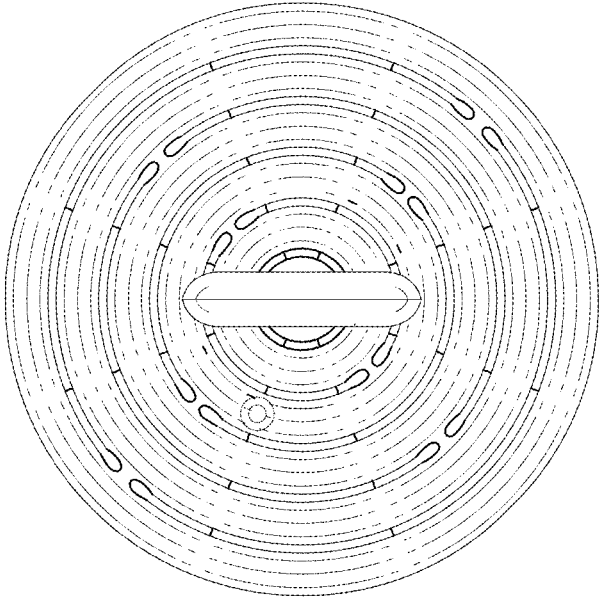

FIG. 13

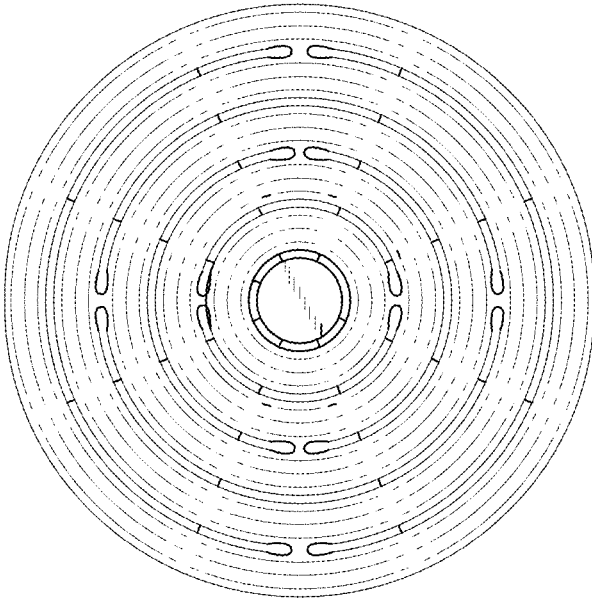

FIG. 14

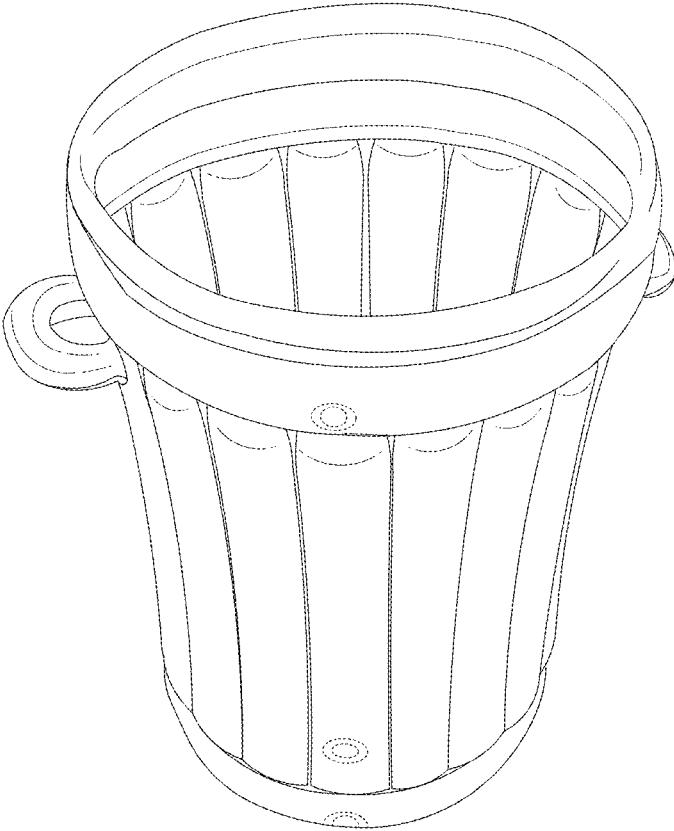

FIG. 15

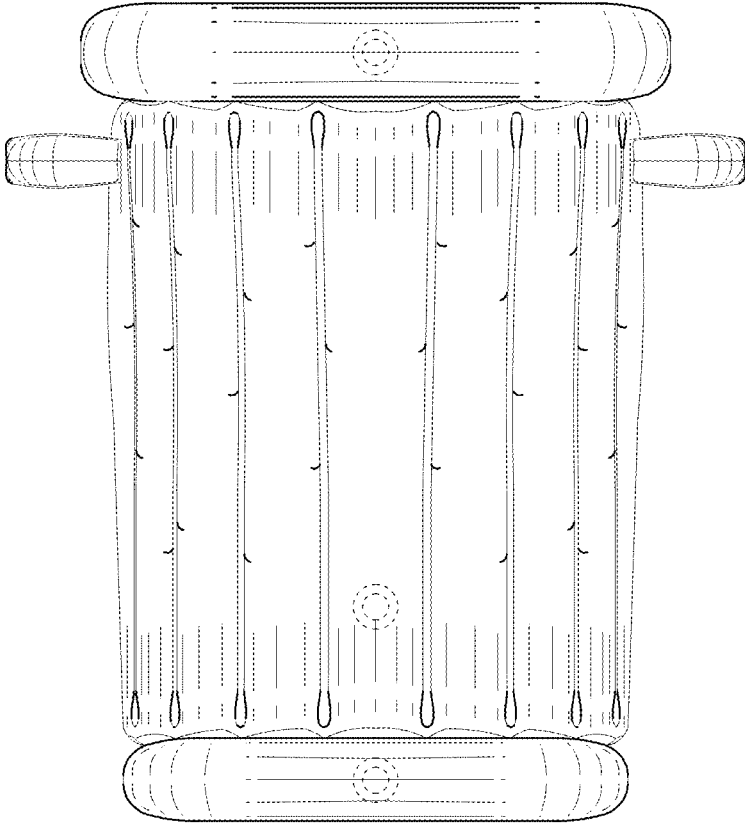

FIG. 16

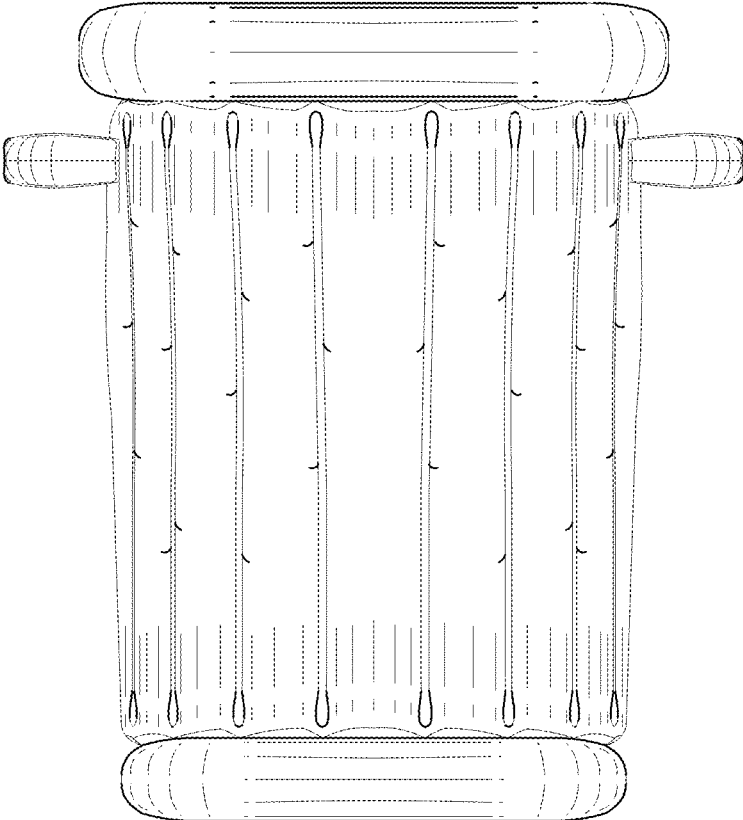

FIG. 17



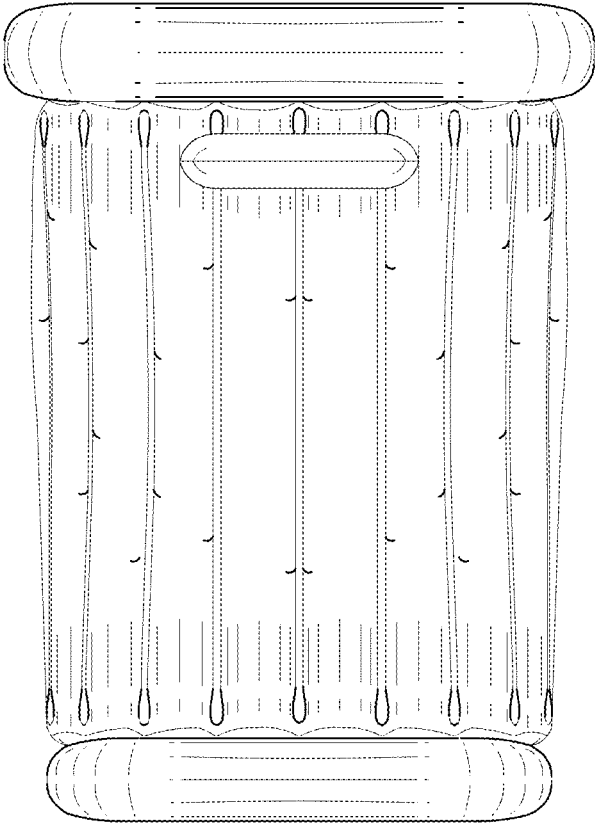

FIG. 18

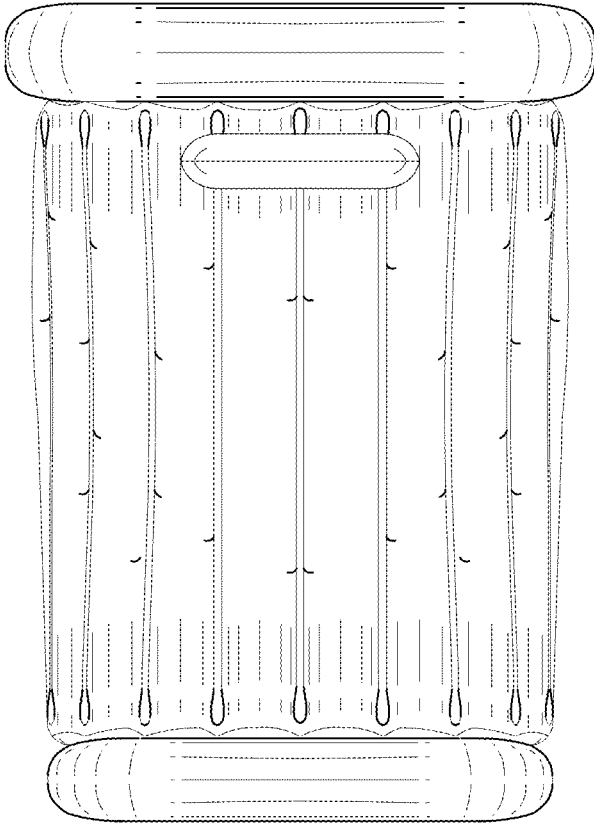

FIG. 19

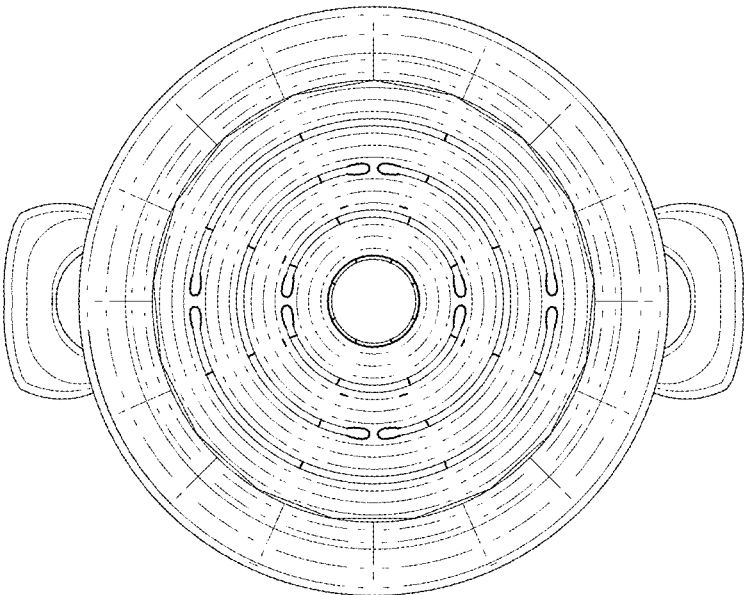

FIG. 20

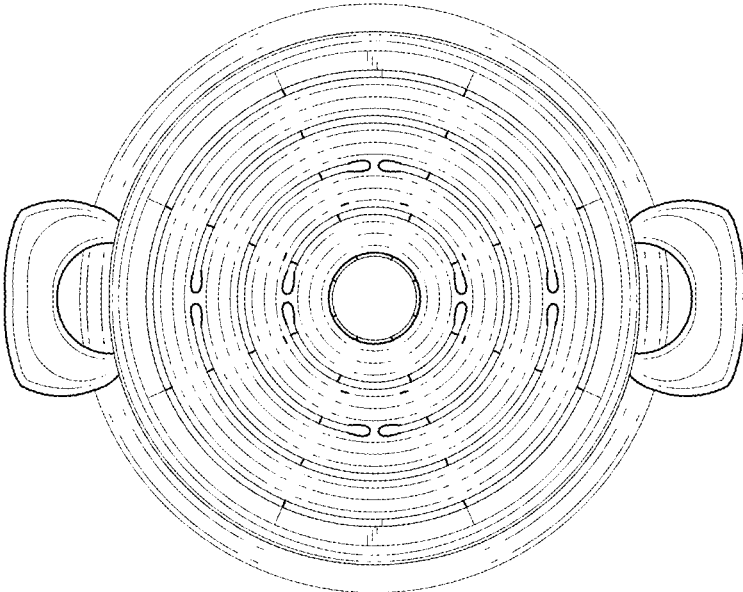

FIG. 21